



MITTELSTOCKSCHIRM

—
Prostor P50
—



Schönes und modernes Design

Leicht und einfach zu bedienen

Perfekt zu kombinieren mit den Modellen P3 und P4

Verlängerung (1m) serienmäßig mitgeliefert



Spezifikationen, Befestigungen und Zubehör

ABMESSUNGEN

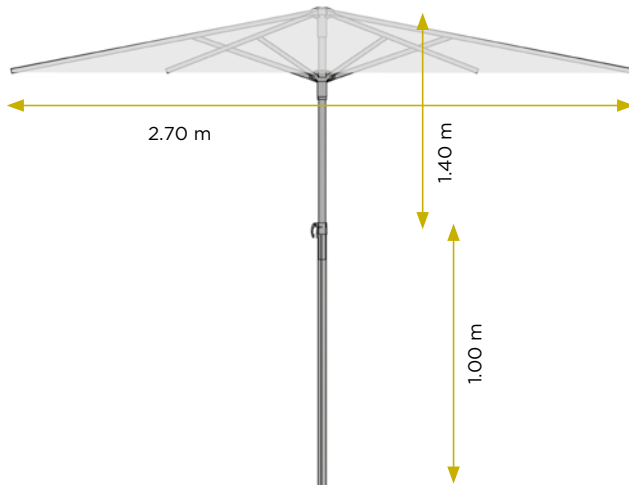

FARBEN

Sehe Seite 30

BEFESTIGUNG

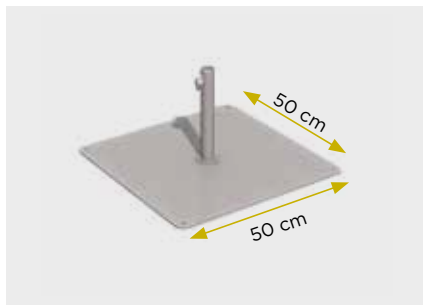

Bodenplatte
feuerverzinkt, 18 kg
Ohne Befestigungsmaterial geliefert



Aluminiumsockel
lackierter Aluminiumdeckel
bis zu 25 kg mit Sand zu füllen.



Serienmäßige Lieferung mit einer Polyester-Schutzhülle für eine lange Lebensdauer Ihres Schirms



Lenkrollen mit oder ohne Bremse, damit Sie Ihren Schirm problemlos umstellen können.



Produktvideo

Haben wir Sie neugierig gemacht? Dann scannen Sie den QR-Code ein, um sich das Produktvideo auf Ihrem Smartphone anzuschauen. Oder gehen Sie zu: www.prostor.be



FARBEN

Bekennen Sie Farbe an Ihrem Schattenplatz

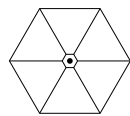

Natural White



Butter Cup

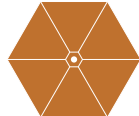

Bitter Orange

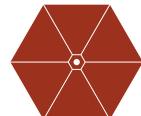

Terra Cotta



Traffic Red



Black Widow

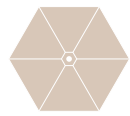

White Sand

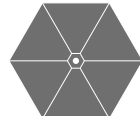

Platinum Grey



Carbon Grey

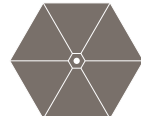

Taupe



Denim Blue



Leaf Green



Farbecht



Atmungsaktiv und wasserabweisend



Antifungizid



Unterhaltfreundlich



UV-Schutz



100% spindüsengefärbt



Farbeständigkeit

100% Olefin: spindüsengefärbt

Gewicht: 190 g/m²

Farbbeständigkeit: 7-8/8 (Standard ISO 105 B04)

Wasserabweisend

UV: über 97% Schutz vor Uv-Strahlen

Pflege: alle bespannungen sind waschbar und können problemlos ersetzt werden.

Stillvolle Verarbeitung von Arm und Rahmen in eloxiertem Aluminium



100% recycelbar



Zubehör

Schutzhülle

Schutzhülle für 1 Schirm, damit Ihr Schirm noch länger hält.



Standard